

survitec

# COMMERCIAL LIFERAFT RANGE

PROVIDING CRITICAL SAFETY SOLUTIONS





# CONTENTS



**4**

Complete  
Safety  
Solutions  
Provider

**5**

Leading  
Liferaft  
Brands

**6**

Liferaft Rental

**7**

RFD - The  
Frontier  
Of Survival  
Technology

**8**

RFD Surviva

**10**

RFD  
Surviva  
Self Righting

**11**

RFD Surviva  
Reversible &  
RFD Means of  
Rescue (MOR)

**12**

RFD Ferryman

**13**

RFD Seasava

**14**

SurvitecZodiac -  
Innovative Marine  
Safety Heritage

**15**

SurvitecZodiac  
Liferaft

**17**

SurvitecZodiac  
Self-Righting

**19**

DSB - SurvitecZodiac  
Open Reversible

**21**

DSB - Liferaft  
Manufacturing  
Excellence

**22**

DSB LR07

**23**

DSB LR97SR  
Self-Righting

**24**

Heating  
Blanket  
System

**25**

Liferafts  
Spares &  
Accessories

**26**

Liferaft  
Servicing



# COMPLETE SAFETY SOLUTIONS PROVIDER - EVERYTHING YOU NEED TO REMAIN SAFE AND COMPLIANT.

Now that Survitec is the world's largest maritime safety business, we are in a position to turn the whole industry onto a different heading. We are already thinking more radically about how we can assist our customers in their pursuit of continuous improvement – how to do things faster, better, cheaper or easier.

With more liferafts, lifejackets, fire systems, safety products and service stations around the world than our nearest competitor, nobody can offer better last mile global coverage than Survitec can. We are determined to use our size and strength to take maritime safety in a different direction – one that delivers new benefits to your business.

Whether your requirements are for one-off product sales or for complete safety asset supply and management, our dedicated teams are always ready to listen to your challenges and are on hand to offer a comprehensive solution, tailored for your business.

Throughout our 160-year history, Survitec has remained at the forefront of innovation, design and application engineering and is the trusted name when it comes to critical safety and survival solutions.

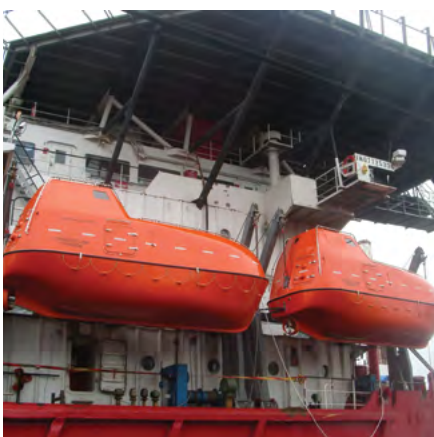
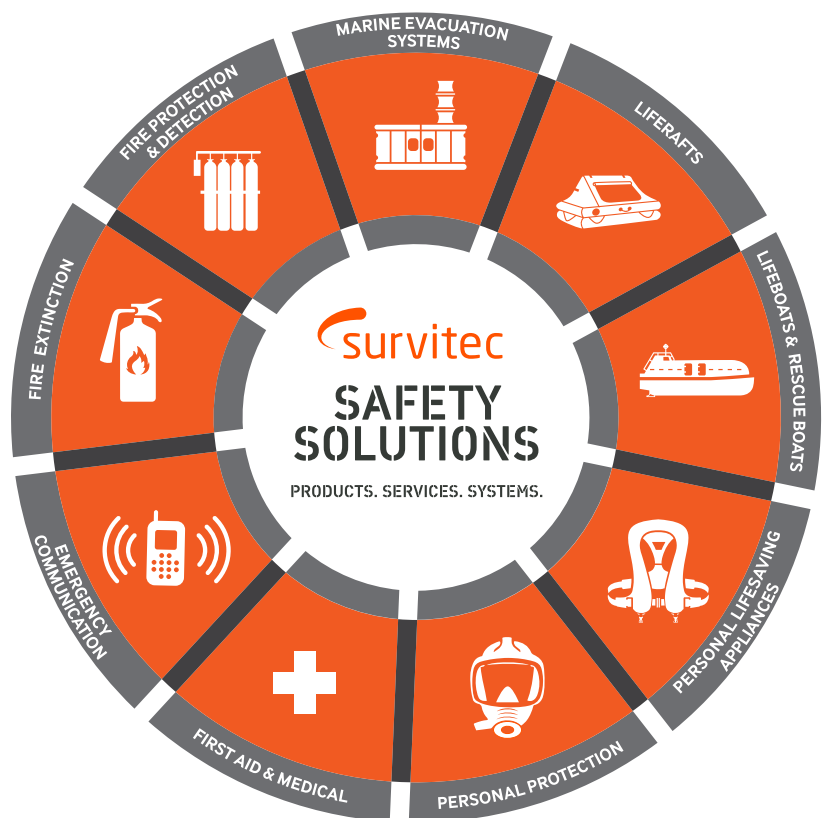

# SURVITEC

## LEADING LIFERAFT BRANDS OFFERING CUSTOMERS LONGEVITY, QUALITY AND MANUFACTURING EXCELLENCE.

Within our liferaft portfolio we offer some of the most trusted brands available including, RFD, SurvitecZodiac and DSB. Every brand shares the same key focus, ensuring Survitec offer customers longevity, quality and manufacturing excellence.

As the world-leader in critical safety and survival solutions, you can be assured of dealing with a robust, reliable and sustainable organisation that is equipped and experienced to handle your liferaft hire needs with minimum fuss. We can equip your vessel with its liferaft needs through product supply or a rental agreement.

In addition, we offer unmatched after-market solutions including the largest service network available across key ports and locations globally, helping to ensure your equipment receives only the very best care and attention throughout its entire safety lifecycle.



# LIFERAFT RENTAL SOLUTIONS

As the world-leader in critical safety and survival solutions, you can be assured of dealing with a robust, reliable, and sustainable organisation that is equipped and experienced to handle your liferaft needs with minimum fuss.

By choosing a rental contract with Survitec, there is no capital investment required. The prices are fixed, meaning you will never be hit with any unforeseen costs, allowing you to plan and budget more accurately.

We offer a straightforward administration approach with a key account manager, backed up by an experienced global customer service team, facilitating all the preparation and logistics of your liferaft exchange. Above all, you can count on us to provide you with complete peace of mind.

For some years we have successfully operated rental programmes with over 1,300 customers - from the biggest tankers to the smallest fishing fleet and with our trusted portfolio of approved liferaft brands you can be sure you always have the best quality products on board.

## KEY BENEFITS

- ✓ Liferafts are replaced with a new approved set
- ✓ Comprehensive network, ensuring availability in all key ports world wide
- ✓ Supports short port stays
- ✓ Reduces the amount of handling required
- ✓ Offers a full guarantee for the duration of the rental period
- ✓ Facilitates both an overall cost reduction and better cost management through one fixed annual charge
- ✓ Less transportation required
- ✓ Highly skilled technicians, ensuring rafts are always in compliance with regulations

## CONVENIENT AND COST EFFECTIVE

With a liferaft rental agreement you will experience several benefits for liferaft management. A key element of the Survitec concept is based on a single point of contact taking care of the due-date monitoring and arrangements for exchange of your liferafts. With this unique offer, you not only save time to focus on other operational duties, there is also a significant reduction in costs.

- ✓ Predictable costs
- ✓ Reduced risk – avoiding replacement costs
- ✓ No investment required certificates
- ✓ No initial investments of rafts



## ALWAYS COMPLIANT, ALWAYS ON BOARD

All our rental rafts are type and class approved, certificated and ready to use. Our teams around the world work hard to ensure your rafts are ready when and where they need to be. We will be waiting at your berth with your replacement rental rafts when you need, ready to go. We offer a variety of class approved, certificated and ready to use Survitec rafts:

- ✓ Option of Annual Liferafts (12 months) or Extended Service Liferafts (30 months) exchange.
- ✓ Throw over and davit launch options
- ✓ 30, 60 or 90-day due-date notifications when your raft needs exchanging
- ✓ 6 – 35-man size options

Additionally, we offer a service completion guarantee, achieved through due date monitoring, proactive service planning, dedicated technical support, giving operators access to their compliance status and safety certificates.



# RFD

## THE FRONTIER OF SURVIVAL TECHNOLOGY

Survitec was formerly known as the Inflatable Systems Division of Wardle Storeys Ltd. Its history dates to 1920, when RFD was formed and named after its founder - Reginald Foster Dagnall. Today, the RFD brand is world renowned and a frontier of marine safety.

RFD products and technologies play a pioneering role in the marine safety industry, offering an uncompromising commitment to deliver robust, reliable and safe solutions which surpass the highest standards.

With a wealth of over 90 years' experience, RFD remains at the forefront of survival technology, offering both cutting edge design and manufacturing excellence, ensures availability of technologically advanced and award winning safety products for marine customers worldwide. Key milestones in RFD history include the introduction of the first welded inflatable liferaft, shortly followed by the development of the first Marine Evacuation System (MES).



## KEY FEATURES

- ✓ MED approved
- ✓ Fully enclosed double-skinned high-visibility canopy complete with retro-reflective tape
- ✓ Non-inflatable easy access boarding ramp
- ✓ High volume water pockets to ensure maximum stability when inflating
- ✓ Canopy fitted with LED light ensuring maximum visibility
- ✓ Fully insulated floor to ensure maximum thermal protection
- ✓ Stowed in lightweight, streamlined Glass Reinforced Plastic (GRP) containers enabling maximum deck space utilisation – various container options available
- ✓ Available with SOLAS 'A' and 'B' emergency pack configuration
- ✓ Sizes 12-25 also available as davit launch options
- ✓ Grey and black container colour options available on request

## RFD SURVIVA

4, 6, 8, 10,  
12, 16, 20, 25  
persons



## MANUFACTURED TO THE HIGHEST QUALITY STANDARDS

The RFD Surviva liferaft is manufactured to the highest quality standards, using corrosion and abrasion resistant Polyurethane coated textile ensuring maximum durability and longevity.

Available in both throw over and davit launch options and approved for storage in a variety of different designed GRP containers, the RFD Surviva range offers customers unparalleled flexibility when utilising space onboard vessels.

Certified to meet all major flag requirements the RFD Surviva liferaft is approved for a max stowage height of up to 46 metres and is additionally supported by an extensive global service station network, helping to ensure your RFD Surviva liferaft will continue to be maintained to the highest standards by full trained and approved service technicians no matter the location.



# OPTIONS AVAILABLE

## MK10 Cylindrical Container

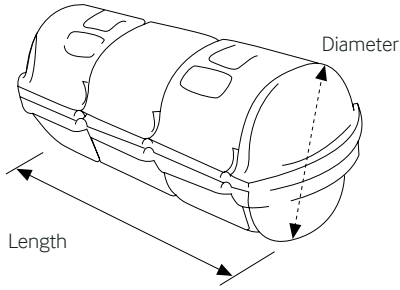

## MK14 Cylindrical Container

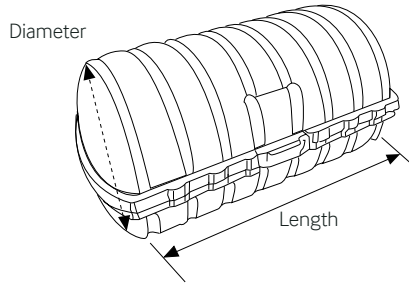

## Flat Pack Container

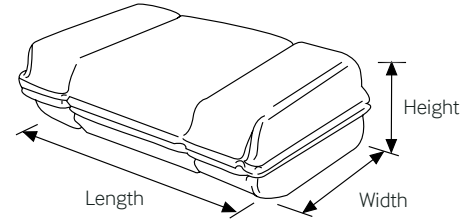

SOLAS A PACK			
Rated Capacity	Length mm	Diameter mm	Weight Approx Operational Kg
4*	1160	435	56
6	1262	485	76
8	1262	485	80
10	1390	535	100
12	1390	535	109
16	1540	535	137
20	1636	585	158
25	1636	585	178
12 DL	1390	535	114
16 DL	1540	535	139
20 DL	1636	585	160
25 DL	1636	585	183

SOLAS B PACK			
Rated Capacity	Length mm	Diameter mm	Weight Approx Operational Kg
4*	1160	435	48
6	1160	435	57
8	1160	435	57
10	1262	485	80
12	1262	485	85
16	1390	535	103
20	1540	535	109
25	1540	535	128
12DL	1262	485	90
16DL	1390	535	107
20DL	1540	535	120
25DL	1540	535	133

SOLAS A PACK			
Rated Capacity	Length mm	Diameter mm	Weight Approx Operational Kg
6	1066	556	76
10	1166	556	99
12	1156	584	108
16	1308	685	139
20	1308	685	160
25	1308	685	180
12DL	1156	584	113
16DL	1308	685	141
20DL	1308	685	174
25DL	1308	685	184

SOLAS B PACK			
Rated Capacity	Length mm	Diameter mm	Weight Approx Operational Kg
6	1066	556	57
10	1156	584	74
12	1156	584	79
16	1156	584	101
20	1156	584	106
25	1308	685	130
12 DL	1156	584	92
16 DL	1156	584	106
20 DL	1308	685	123
25 DL	1308	685	135

SOLAS A PACK				
Rated Capacity	Length mm	Width mm	Height mm	Weight Kg
4*	900	646	310	53
6	985	670	435	76
8	985	670	435	86
10	1190	650	315	101
12	1190	650	315	110
20DL	1525	820	505	160
25DL	1525	820	505	183

SOLAS B PACK				
Rated Capacity	Length mm	Width mm	Height mm	Weight Kg
4*	900	646	310	45
6	900	646	310	57
8	985	670	435	62
10	1190	650	315	85
12	1190	650	315	91
20DL	-	-	-	-
25DL	1525	820	505	153

## Davit Launch Raft Heights

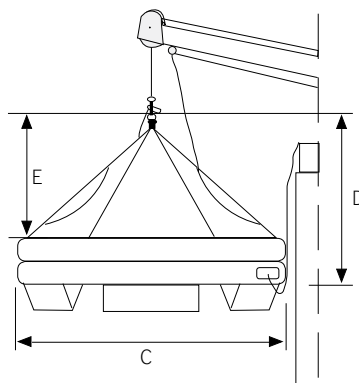
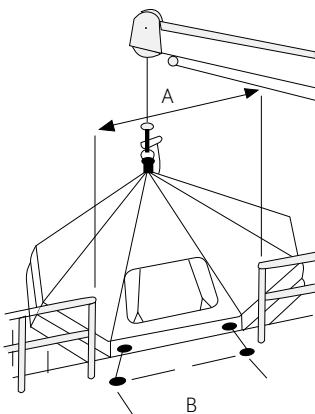

Rated Capacity	A mm	B mm	C mm	D mm	E mm
12	1600	1000	2860	1891	1300
16	1700	1000	3270	2065	1420
20	1800	1000	4070	2065	1400
25	1800	1000	4070	2270	1540

\*4 person is non SOLAS



**FULLY ENCLOSED HIGH-VISIBILITY CANOPY COMPLETE WITH RETRO REFLECTIVE TAPE**

**THROW OVER - SOLAS A PACK**

Rated Capacity	Length mm	Diameter (mm)	Weight Kg
25	1308	685	-
35	1670	800	335

**THROW OVER - SOLAS B PACK**

35	1550	800	264
----	------	-----	-----

**DAVIT LAUNCH - SOLAS A PACK**

Rated Capacity	Length mm	Diameter (mm)	Weight Kg
25	1308	685	212
35	1670	800	350

**DAVIT LAUNCH - SOLAS B PACK**

25	1636	585	-
25	1308	685	154
35	1550	800	279

**DAVIT LAUNCH CONTAINER**

Rated Capacity	A	B	C	D	E
25	Min 1800	1640	5933	3620	2585
35	Min 1800	784	5053	3100	3200

**RFD SURVIVA SELF RIGHTING**

**25, 35 persons**



**EASY-ACCESS BOARDING RAMP**

The 25 and 35 person self-righting throw overboard and davit Launch liferafts are an continuation of the Surviva liferaft range, manufactured to the highest quality standards. These automatically self righting liferafts are utilised by a number of differing commercial vessel types but notably on Ro-Ro passenger vessels.

**KEY FEATURES**

- ✓ Automatically Self Righting
- ✓ Fully enclosed high-visibility canopy complete with retro reflective tape
- ✓ Non-inflatable, easy-access boarding ramp
- ✓ Fitted with external and internal lighting to ensure maximum visibility
- ✓ Available with SOLAS 'A' and 'B' emergency pack configuration
- ✓ Grey and black container colour options available on request

# RFD SURVIVA REVERSIBLE

50,100  
persons



## SELF-ERECTING CANOPY

The canopied fully reversible inflatable liferaft conforms to Resolution MSC.81 (70) of the IMO. It also meets ISO 15738:2002 (MED) (JG) (TC) specifications, as required in gas inflation systems for inflatable life-saving appliances.

The 50-person Surviva is ideal for use with the Survitec slide based Marine Evacuation Systems (MES). The 100-person option consists of 2 x 50-person liferafts packed in the same container and connected for maximum capacity.



## KEY FEATURES

- ✓ Two super-imposed buoyancy chambers provide a high freeboard
- ✓ Suspended floor in between two buoyancy chambers
- ✓ Self-erecting canopy operated by a shuttle-like action provided by its own buoyancy
- ✓ Robust weather protection provided by a canopy regardless of the liferaft deployment method
- ✓ Each liferaft is furnished with boarding facilities, external and internal lighting, lifelines, a drogue (sea anchor), a rescue line and quito as well as other necessary items of equipment
- ✓ Grey and black container colour options available on request
- ✓ Inflatable reversible Boarding ramp

# RFD MEANS OF RESCUE (MOR)

12, 25  
persons



## HIGHLY STABLE OBLONG SHAPED

The RFD Means of Rescue device is a rectangular inflatable buoyant platform designed to rescue survivors from the water or another vessel. This MOR device is not classed as a liferaft; it is a water-borne device that provides a means of rescue in an emergency.

The RFD MOR is designed and installed in accordance with the regulations specified in IMO.



## KEY FEATURES

- ✓ Container is a distinctive bright orange to distinguish from a liferaft
- ✓ Compatible with a standard liferaft cradle
- ✓ Securing strap assembly specific to the MOR is available (hydrostatic release unit NOT included)
- ✓ Weight: 137kg
- ✓ Container Dimensions: Length 1530mm x Diameter 580mm
- ✓ Manufactured from polyurethane fabric

### CYLINDRICAL CONTAINER

Rated Capacity	Length mm	Width mm	Height mm	Weight Kg
10	1275	610	590	120
25	-	-	-	-



## RFD FERRYMAN

25, 30, 37, 50,  
65, 100, 130  
persons



### KEY FEATURES

- ✓ Manufactured from durable polyurethane-coated nylon material
- ✓ Lead weighted water pockets to ensure maximum stability when inflated
- ✓ Highly visible retro-reflective strips
- ✓ Fitted with lights for night detection
- ✓ Stowed in lightweight GRP containers with multiple container options available
- ✓ Can be packed with either an 'E', 'HSC' or 'SOLAS B' type emergency pack
- ✓ Easy access boarding ramps located around the liferaft
- ✓ Grey and black container colour options available on request

### FITTED WITH LIGHTS FOR NIGHT DETECTION

Survitec's Ferryman open reversible liferaft (ORL) combines forward-thinking design with over 90-years of unparalleled knowledge and expertise in the marine safety industry.

Designed specifically for passenger vessels operating in coastal and inland waterways, and for high-speed craft, the fully open and reversible RFD Ferryman Liferaft remains the industry's premium ORL.

RATED CAPACITY (MED/UK)	DIAMETER. INFLATED SIZE (M)
30/37	4.50
50/65	5.81
100/130	5.81 by 2 liferafts

#### CYLINDRICAL CONTAINER

Rated capacity	Length (mm)	Diameter (mm)	Weight Approx operational (kg)
30/37	1390	565	121
50/65 Op1	1636	615	175
50/65 Op2	1308	685	174
100/130	1690	775	339

#### FLATPACK CONTAINER

Rated capacity	Length (mm)	Height (mm)	Width (mm)	Weight Approx operational (kg)
30/37	1200	415	650	124
50/65	1530	380	770	177

All dimensions are approximate values



**WEIGHTED WATER POCKETS  
TO ENSURE MAXIMUM  
STABILITY WHEN INFLATED**



## RFD SEASAVA PRO-ISO

4, 6,  
8, 10, 12  
persons



### INSULATED FLOOR FOR INCREASED COMFORT

The Seasava is based on the highly successful SOLAS-approved Survitec MK4 range, the canopied inflatable throw over Seasava Pro-ISO liferaft has been developed specifically to accommodate the requirements of smaller vessels with limited deck space such as fishing boats.

Meeting the stringent ISO9650-1 standard for inflatable liferafts, the RFD Seasava Pro-ISO liferaft is one of the most robust and durable smaller liferaft options available.

<24 HOURS				
Rated capacity	Length (mm)	Diameter (mm)	Height (mm)	Weight (kg)
4	800	570	220	36.1
6	800	570	250	42.4
8	800	570	250	47.8
10	800	570	300	54
12	800	570	300	57
>24 HOURS				
4	800	570	250	47.8
6	800	570	300	57.7
8	820	640	310	65.9
10	820	640	350	77
12	820	640	350	84.4
SOLAS B				
4	800	570	250	39.5
6	800	570	300	45.1
8	800	570	300	50.6
10	820	640	350	55.8
12	820	640	350	58.8

### KEY FEATURES

- ✓ Manufactured from durable PU coated polyester
- ✓ Extended service period of 3 years, reducing ongoing costs
- ✓ Manufactured from long-lasting, corrosion and abrasion-resistant material
- ✓ High-volume water pockets to ensure maximum stability
- ✓ Simple-to-close canopy is manufactured to the highest SOLAS standards, providing added protection from the elements
- ✓ Semi-rigid boarding ramp allows for quick, easy and safe boarding
- ✓ Interior lifelines help occupants stabilise themselves during heavy seas
- ✓ Vacuum-packed for prolonged durability
- ✓ Insulated floor for increased comfort
- ✓ Comes with the following emergency pack options: <24, >24, or SOLAS B pack
- ✓ Orange, high-visibility canopy with retro-reflective panels to help facilitate the search and rescue process
- ✓ Grey and black container colour options available on request

# SURVITECZODIAC

## INNOVATIVE MARINE SAFETY HERITAGE

SurvitecZodiac is an exceptional addition to Survitec with its focus on market longevity, quality and manufacturing excellence. The SurvitecZodiac brand has a heritage of supplying the marine market with reliable and innovative equipment. Leveraging the experience and expertise of their dedicated workforce

to manufacture, supply and service a wide variety of products.

SurvitecZodiac are most famously known for the successful supply of liferafts and MES globally to merchant ships, ferries, and cruise ships.





# SURVITEC ZODIAC LIFERAFT

4-50 persons



## EXTREMELY STRONG AND SAFE WHEN LOADED

Built to meet the needs of small passenger vessels, fishing vessels and high speed craft the SurvitecZodiac liferaft is the first choice for many operators.

Designed and manufactured out of our highly successful manufacturing facility in Chevanceaux, France, the SurvitecZodiac liferaft is chosen for its advanced design and unique method of construction. Additionally, due to the fabric weight and structure, SurvitecZodiac throw over liferafts are easy to service and fit in light, small sized but strong, glass reinforced containers.

The Throw Over option of this raft can be dropped from a height of up to 36 meters and meets all of the required approval standards.

## KEY FEATURES

- ✓ Manufactured using a durable polyurethane coated fabric
- ✓ Assembled using Thermobonding™ (advanced hot assembly technique)
- ✓ Consistent (computer-controlled technique)
- ✓ Inert to aging factors in the marine environments
- ✓ Extremely strong and safe when loaded
- ✓ Easy to service and fit in small light glass reinforced container
- ✓ Can be dropped from up to 36 meters
- ✓ Grab bags are sealed in strong watertight bags, secured inside the liferaft
- ✓ Available in white, grey or black container colour options

## Throw Over - Cylindrical Container

SOLAS A PACK				
Rated Capacity	Length mm	Width mm	Height mm	Weight Kg
4	1155	470	435	56
6	1260	520	485	76
8	1260	520	485	80
10	1156	612	584	99
12	1156	612	584	108
16	1308	713	685	139
20	1308	713	685	180
25	1308	713	685	180
37	1560	852	835	250
50	1560	952	960	434
SOLAS B PACK				
Rated Capacity	Length mm	Width mm	Height mm	Weight Kg
4	1155	470	435	48
6	1155	470	435	57
8	1155	470	435	57
10	1260	520	485	80
12	1260	520	485	85
16	1156	612	584	101
20	1308	713	685	106
25	1308	713	685	130
37	1450	800	740	163
50	1560	852	835	221

## Low Profile Container (LPC)

SOLAS A PACK				
Rated Capacity	Length mm	Width mm	Height mm	Weight Kg
4	924	574	359	54
6	985	670	435	76
8	985	670	435	86
10	1190	650	315	101
12	1190	650	315	110
16	1160	752	505	126
20	1160	752	505	141
SOLAS B PACK				
Rated Capacity	Length mm	Width mm	Height mm	Weight Kg
4	924	574	359	46
6	985	670	435	57
8	985	670	435	62
10	1190	650	315	85
12	1190	650	315	90
16	1160	730	408	87
20	1160	730	408	95.5



Xtrem Container

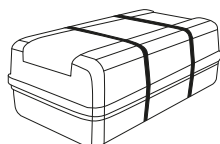

Low Profile Container (LPC)

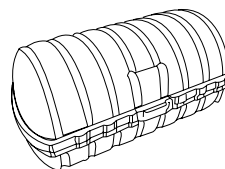

Throw Over Cylindrical Container

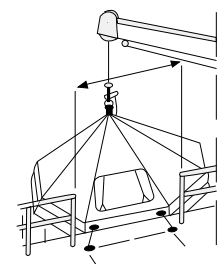

Davit Launch

## Xtrem Container

SOLAS A PACK				
Rated Capacity	Length mm	Width mm	Height mm	Weight Kg
6	790	555	340	58
8	840	570	340	74
10	940	640	364	85
12	940	640	364	96
16	1100	650	370	120
SOLAS B PACK				
6	790	555	270	42
8	840	570	340	54
10	940	640	364	60
12	940	640	364	64
16	1100	650	370	82

## Davit Launch - Stackable Container Single Storage

SOLAS A PACK				
Rated Capacity	Length mm	Width mm	Height mm	Weight Kg
25	1450	820	915	250
37	1500	955	1115	350
SOLAS B PACK				
25	-	-	-	-
37	1450	820	915	240

## Davit Launch - Cylindrical Container

SOLAS A PACK				
Rated Capacity	Length mm	Width mm	Height mm	Weight Kg
8	1275	610	590	84
12	1156	612	584	113
16	1156	612	584	152
16*	1308	713	685	141
20	1308	713	685	163
25	1308	713	685	185
37	1500	950	945	275
SOLAS B PACK				
8	1160	560	513	63
12	1156	612	584	92
16	1156	612	584	106
16*	-	-	-	-
20	1308	713	685	123
25	1308	713	685	135
37	1450	800	740	195
150	1930	1150	1120	490

\* Height of stowage = 36m

## Davit Launch - Stackable Container Double Storage

SOLAS A PACK				
Rated Capacity	Length mm	Width mm	Height mm	Weight Kg
25	1450	820	1650	450
37	1500	955	2060	660
SOLAS B PACK				
25	-	-	-	-
37	1500	955	2060	440

## KEY FEATURES

- ✓ Manufactured with a durable polyurethane-coated fabric
- ✓ Assembled using Thermobonding™, the advanced SurvitecZodiac hot assembly technique.
- ✓ Provides extreme strength and safety when loaded
- ✓ Supplied in light, short-sized, strong cylindrical containers
- ✓ Containers are a distinct orange colour
- ✓ Can also be used on the end of pontoons for rescue situations
- ✓ Suitable for 10 stretcher borne persons

## MOR

CYLINDRICAL CONTAINER				
Rated Capacity	Length mm	Width mm	Height mm	Weight Kg
10	1275	610	590	120

## SURVITECZODIAC MEANS OF RESCUE (MOR)

The MOR liferaft has been specially developed to meet the latest requirements of roll-on/roll-off (Ro/Ro) passenger ships and is fully approved for use thereon.

MOR liferafts are now mandatory on Ro/Ro passenger ships as they provide a safe transfer of survivors from sea level to the deck of a ship in rescue situations.







## SURVITECZODIAC SELF-RIGHTING

6 – 37 **persons**  
(throw over)

50 – 150 **persons**  
(davit launch)



### UNIQUE PATENTED DESIGN

The Survitec range of self-righting liferafts meets the latest self-righting requirement introduced for roll on/roll off passenger ships. A unique patent design means the raft will self-right in less than 1 minute.

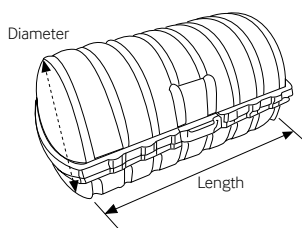

Throw Over Cylindrical Container

### KEY FEATURES

- ✓ Unique patented design
- ✓ The 25, 37, 50 and 150 person rafts are available with SOLAS 'A' or 'B' emergency equipment packs
- ✓ The 50-person raft is specially designed to be used in conjunction with the DBC/SurvitecZodiac Marine Evacuation System (MES)
- ✓ Available with standard or self-stacking container system
- ✓ Available in white, grey or black container colour options

### Throw Over Self Righting - Cylindrical Container

SOLAS A PACK				
Rated Capacity	Length mm	Width mm	Height mm	Weight Kg
6	1160	560	513	72
8	1160	560	513	85
10	1275	610	590	98
12	1275	610	590	110
25	1450	800	740	200
37	1500	950	945	305

SOLAS B PACK				
Rated Capacity	Length mm	Width mm	Height mm	Weight Kg
6	1160	560	513	58
8	1160	560	513	69
10	1160	560	513	73
12	1160	560	513	82
25	1530	680	620	150
37	1450	800	740	209

### Throw Over Self Righting - Cylindrical Container

SOLAS A PACK				
Rated Capacity	Length mm	Width mm	Height mm	Weight Kg
50	1560	952	960	360
100 V	1935	1040	1015	560
150	3340	1050	1035	995

SOLAS B PACK				
Rated Capacity	Length mm	Width mm	Height mm	Weight Kg
50	1560	852	835	235
100 V	2000	970	925	415
150	3340	1050	1035	845
150 V	2100	1050	1035	523

### Davit Launch Self Righting - Stackable Container Single Storage

SOLAS A PACK				
Rated Capacity	Length mm	Width mm	Height mm	Weight Kg
25	1450	820	915	260
37	1500	955	1115	370

SOLAS B PACK				
Rated Capacity	Length mm	Width mm	Height mm	Weight Kg
25	1530	820	796	200
37	1560	915	1020	270

### Davit Launch Self Righting - Stackable Container Double Storage

SOLAS A PACK				
Rated Capacity	Length mm	Width mm	Height mm	Weight Kg
25	1530	820	1650	480
37	1500	955	2060	700

SOLAS B PACK				
Rated Capacity	Length mm	Width mm	Height mm	Weight Kg
25	1530	820	1420	360
37	1560	915	1865	500





Open Reversible - 151 Persons

## SURVITECZODIAC OPEN REVERSIBLE

4-151  
persons



### CAPACITIES FROM 4 TO 151 PERSONS ON BOARD

Built to meet the needs of small passenger vessels, high speed crafts and fishing vessels, the Survitec Open Reversible inflatable liferaft (ORIL) range is the optimum choice for many operators. Ideal for accommodating up to 151 people, these rafts are immediately boardable after drop, allowing for safe and fast recovery of all passengers. Designed and manufactured out of our highly successful facility in Chevanceaux, France, the open reversible is designed and constructed to withstand arduous environments at sea, supported by its durable polyurethane fabric and superior inflation time.

All of the Survitec ORIL rafts are specifically manufactured to be compact when stored on-board, making them an effective choice when space and service time are at a premium.

### KEY FEATURES

- ✓ Assembled using Thermobonding™ (advanced hot assembly technique)
- ✓ Ensuring:
  - Consistent (computer- controlled technique)
  - Inert to aging factors in the marine environments
  - Easy to service and fit in small light glass reinforced container
- ✓ Equipment packs sealed in strong watertight bags
- ✓ Paramount evacuation time
- ✓ Venturi technology - allows for weight / volume savings (50-151 option)
- ✓ Available in white, grey or black container colour options

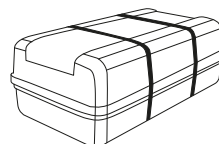

Low Profile Container (LPC)

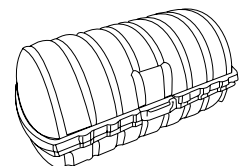

Throw Over Cylindrical Container

## ORIL - Cylindrical Container

ORIL				
Rated Capacity	Length mm	Width mm	Height mm	Weight Kg
6	1020	476	440	40
10	1020	476	440	51
20	1160	560	513	77
30	1275	610	590	100
37	1275	610	590	104
USCG APPROVED				
6	1020	476	440	36
10	1020	476	440	46
20	1160	560	513	76
30	1275	610	590	100
TC APPROVED				
9	1020	476	440	36
15	1020	476	440	46
30	1160	560	513	76
45	1275	610	590	100

## Valise

ORIL				
Rated Capacity	Length mm	Width mm	Height mm	Weight Kg
4 (TC)	690	250	300	21
6(USCG)	690	250	300	30

## Low Profile Container (LPC)

ORIL				
Rated Capacity	Length mm	Width mm	Height mm	Weight Kg
6	825	540	318	38
10	890	520	333	51
20	965	596	380	77
30	1088	666	390	99
37	1160	730	408	101
USCG APPROVED				
4	825	540	318	30
6	825	540	318	35
10	890	520	333	46
20	965	596	380	75
30	1088	666	390	99
TC APPROVED				
4	825	540	318	30
9	825	540	318	35
15	890	520	333	46
30	965	596	380	75
45	1088	666	390	99

## ORIL - Cylindrical Container

ORIL				
Rated Capacity	Length mm	Width mm	Height mm	Weight Kg
50	1275	800	740	170
65	1275	800	740	190
100	1560	852	835	295
100V	1450	800	740	230
151V	1560	952	960	345
IBA				
50 (US)	1275	680	615	165
75(TC)	1275	680	615	165
100(US)	1560	852	835	305
150(TC)	1560	852	835	305



# DSB

## LIFERAFT MANUFACTURING EXCELLENCE

Our DSB branded products are renowned for their sturdiness of design and long product life. Safety is our top priority; each individual product is designed to offer optimum protection in the most extreme environments. Renowned for excellence in boats DSB quickly transfer their success in boats to other inflatable products including liferafts.





## DSB LR07

6, 8, 10, 12, 16, 20, 25  
persons



### KEY FEATURES

- ✓ Manufactured from PU coated nylon
- ✓ Fully-enclosed double-skinned high-visibility canopy complete with retro-reflective tape
- ✓ Semi-rigid easy access boarding ramp
- ✓ Large water pockets to ensure maximum stability when inflated
- ✓ Fully insulated floor to ensure maximum thermal protection
- ✓ Available in both 'A' or 'B' pack SOLAS compliant emergency pack options
- ✓ Grey and black container colour options available on request

### LARGE WATER POCKETS TO ENSURE MAXIMUM STABILITY WHEN INFLATED

The LR07 is the latest MED-approved liferaft from DSB which provides a quality product that is both durable and cost effective. Stability, insulation, visibility and ease of stowage all feature highly in the design of this liferaft.

Survitec's DSB LR07 davit launch liferafts for 6, 8, 10, 12, 16, 20 and 25 persons are compliant with relevant Marine Equipment Directives and offer a durable and cost-effective quality product. The design of DSB davit launch liferafts optimises stability, insulation, visibility and ease of stowage. As with all davit launch liferafts, each raft is designed to be deployed on a davit and have all passengers boarded before being safely lowered to the water.

LR07	LIFERAFT PACKED IN CONTAINER WITH				WEIGHT	
	A PACK		B PACK		A PACK	B PACK
Raft Size	Length mm	Diameter mm	Length mm	Diameter mm	Weight Kg	Weight Kg
4	1160	435	1160	435	56	48
6	1260	485	1050	610	76	63
8	1260	485	1050	610	80	63
10	1156	584	1260	485	99	80
12	1156	584	1260	485	108	85
12DL	1156	584	1260	485	113	92
16	1308	685	1156	584	139	101
16DL	1308	685	1156	584	141	106
20	1308	685	1156	584	160	106
20DL	1308	685	1308	685	163	123
25	1308	685	1308	685	180	130
25DL	1308	685	1308	685	185	135



## DSB LR97SR SELF-RIGHTING

25, 35, 50,  
100, 150  
persons



### SELF-RIGHTING FEATURE ENSURES THESE RAFTS ALWAYS DEPLOY CORRECTLY

The Survitec range of self-righting throw over Liferasts are compliant with appropriate Marine Equipment Directives (MEDs). Equipped with all the safety features of conventional DSB liferafts, with additional self-righting capability. A jettison type may also be used in conjunction with the DSB Small Inflatable Slide (SIS) and CAT-Slide Marine Evacuation Systems (MES).

Davit launch liferafts are designed to be deployed and boarded at deck level before being lowered to the water in case of an emergency. Whereas throw over rafts will inflate on impact with water, the additional self-righting feature will help to ensure these rafts always deploy correctly.

#### Throw Over

SOLAS A PACK			
Rated Capacity	Length mm	Diameter (mm)	Weight Kg
25	1400	780	230
35	1550	870	335
50	2012	960	458
SOLAS B PACK			
25	1400	780	172
35	1550	870	254
50	2012	786	272
100	2000	1080	624

### KEY FEATURES

- ✓ The 25, 35 and 50 person options are available with SOLAS 'A' or 'B' emergency equipment packs
- ✓ The 100 person option is available with SOLAS 'B' emergency equipment pack
- ✓ Grey and black container colour options available on request

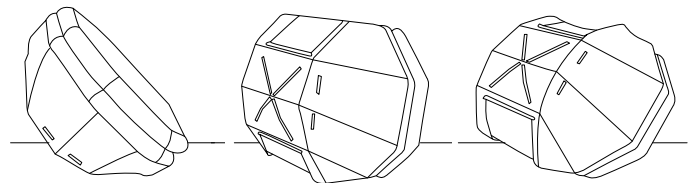

Self-righting capability

#### Davit Launch

SOLAS A PACK			
Rated Capacity	Length mm	Diameter (mm)	Weight Kg
25	1600	790	242
35	1550	870	350
SOLAS B PACK			
25	1400	780	193
35	1550	870	259



## HEATING BLANKET SYSTEM

### POLAR CODE LIFERAFT SOLUTIONS

Designed to both meet and exceed polar code requirements, our polar code liferaft solution provides the ability to maintain the essential functionality of your liferaft at very low temperatures (down to  $-60^{\circ}\text{C}$ ) keeping the liferaft and associated equipment always ready for use and ensuring inflation. This is achieved using a heating blanket system which is placed over the liferaft container. The liferaft was tested after it had been stored at  $-70$  for a total of 50 hours.

Build-up of ice and snow can prove dangerous on board your vessel as it reduces the crafts stability and this then increases the risk of capsizing. Using the heating blanket system provides a superior



guard against excess ice and snow build up on the liferaft, allowing for increased protection.

The heating blanket operates through use of a thermostatic control unit which can manage up to five liferafts and accompanying polar code hydrostatic release units (HRU). It is easy to install on new constructions and perfectly adaptable for retrofits.

Designed for use on all Survitec SOLAS approved liferafts for any vessels looking to be compliant with polar code regulation requirements. The heating blanket has the added benefit of being easily removed when vessels are sailing outside of the defined polar code regions to improve blanket longevity, equally they are easy to fit onto your liferaft prior to entry into a polar code regions for quick and efficient use.



LIFERAFT STORED FOR 50HRS AT  $-70^{\circ}\text{C}$



LIFERAFT INFLATED AFTER BEING STORED FOR 50HRS AT  $-70^{\circ}\text{C}$



### KEY FEATURES

- ✓ Operating temperature: down to  $-60^{\circ}\text{C}$  (tested down to  $-70^{\circ}\text{C}$ )
- ✓ Available for the use with any Survitec Solas approved Liferaft
- ✓ Available in two cradle options and two colours (grey or white)
- ✓ Heating blanket automatically stops or starts at  $+5^{\circ}\text{C}$

**SAFETY AT SEA BEST SECURITY PRODUCT OF THE YEAR AWARD NOMINEE**





# LIFERAFTS SPARES & ACCESSORIES

## HAMMAR - HYDROSTATIC RELEASE SYSTEMS

CM Hammar are the company behind the world famous, lifesaving H2O hydrostatic release unit. They develop, manufacture and supply release units for liferafts and EPIRBs and Remote Release Systems for liferafts, evacuation systems and lifebuoys as well as Hydrostatic Inflators for lifejackets. Survitec can supply all Hammar release units required with your liferaft supply be it through product purchase or rental, this includes the H2O, MRRS and ERRS release unit and systems.

## CRADLES & LASHING ASSEMBLIES

To suit multiple storage needs Survitec offer several cradle solutions with accompanying lashing assemblies to suit varying raft sizes and container options. Our cradles range from deck mounted solutions to adjustable options that can be mounted vertical, horizontal or pushpit mounted. In addition, our lashing assemblies offer security when stored and work efficiently with our HRU systems to ensure quick and efficient access and automatic release if needed in an emergency.

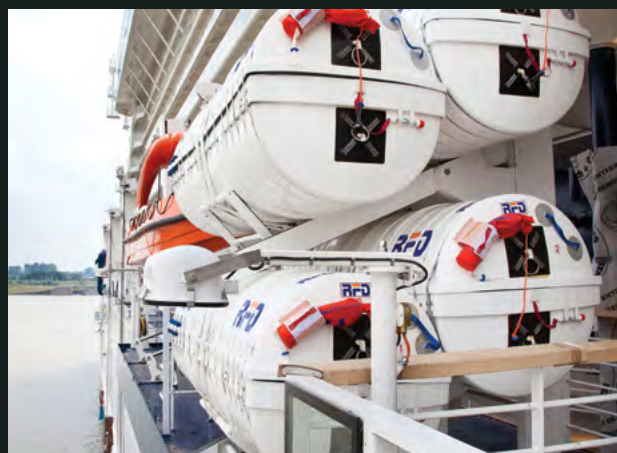

## RACKING

For larger vessels with multiple rafts onboard we offer racking systems. Our racking systems are designed to hold several rafts at any one time of varying size. Equally, rafts can be launched quickly and efficiently in an emergency when required.



## DAVITS & WINCHES

We supply a range of davits & winches to suit your davit liferaft launching requirements, designed to SOLAS and LSA code regulations. All our products are inherently strong, reliable and built to perform in the toughest maritime conditions. Winches, electric motors, control boxes, fall wires and associated equipment are supplied with davits. Standard electrical systems are based on IP56 for non-hazardous area installations. EX-Rated electrical systems can be supplied and installed for hazardous area installations.



# LIFERAFT SERVICING

**At Survitec we believe when you purchase your safety equipment it is only the beginning of your relationship with us. Safeguarding lives through high quality safety equipment is at the heart of everything we do. With over 90 years' total experience to our name, we ensure your equipment receives only the very best care and attention throughout its entire safety life-cycle.**

We are the world leader in the supply, inspection, testing and maintenance of safety and survival equipment. Through our network of 500+ accredited service stations, we are able to offer a truly global service covering 2,000 ports worldwide.

We have a strong reputation for reliability of service and workmanship. Our work is always of a high standard and our technical ability is continuously being upgraded with the latest equipment, facilities and training.

As well as our standard servicing offering we are also able to carry out both major and minor repairs to your liferaft when needed. We have our own in-house cylinder bays and engineering workshops where we investigate the condition of equipment prior to carrying out any extensive repairs.

In order to provide a rapid service turnaround, Survitec service stations hold a host of approved components and spare parts, all of which are fully documented and traceable.

## WHAT'S INCLUDED

All liferafts serviced at an approved Survitec service station will be subjected to a rigorous inspection by a fully qualified technician to ensure it is fit for purpose and maximise its performance if needed in an emergency. Key tasks that will be carried out as part of the servicing procedure include:

- ✓ Perform a liferaft inspection and advise if the liferaft can be serviced or needs to be replaced
- ✓ An opportunity for components to be stripped down, so that all the valves and seals, normally hidden behind various components, are also tested. Any expired, worn or perished parts will be replaced (additional costs may be incurred for the parts, just like an MOT)
- ✓ A pressure test and mechanism test will be performed to ensure the raft is in working order
- ✓ Any general observations that you should be made aware of will be highlighted including any service bulletins or advisories that may have occurred for this product
- ✓ On repacking the liferaft, the service station will ensure it is repacked correctly and will therefore work in an emergency
- ✓ The accredited service station will keep a test report recording how the liferaft performed. Then in the event of an issue, this test report can be consulted

## MANDATORY REQUIREMENT

As a liferaft manufacturer we would always recommend an annual service however depending on your operation and the approval authority you are governed by it may also be a legal requirement.

**SOLAS** – If you are operating under SOLAS, professional liferaft servicing is a legal requirement and must be performed annually

**ISO** – The MCA state that the owner should follow the manufacturers guidelines for servicing, in this case this means performing a professional service annually

## USING AN APPROVED SERVICE STATION

At Survitec we recognise that when it comes to safety there is no margin for error or complacency. We carry out regular and rigorous servicing and maintenance at our stations to ensure that our customers have the best and most reliable survival products on the market.

Additionally, all Survitec and Survitec approved service stations are audited and approved to the highest standards of legislative organisations and government associations as well as the product original equipment manufacturer (OEM).

When organising your liferaft servicing owners should ensure they are using a fully approved service station for the brand of liferaft owned. Authorised service centres will have access to the correct service manuals for your liferaft and would have undergone all of the relevant product training. These highly technical documents are a key tool for the liferaft service engineer.

Not using an authorised service centre could potentially be giving your liferaft the chance to fail. Unauthorised service centres may not use genuine parts from your liferaft manufacturer, and these may end up damaging your liferaft – all liferaft spare parts are not made equal.

## KEY BENEFITS

- ✓ STRATEGICALLY LOCATED SERVICE STATIONS ENSURE MINIMUM DELAY IN THE DELIVERY AND COLLECTION OF EQUIPMENT
- ✓ ALL SURVITEC SERVICE STATIONS ARE QUALITY CONTROLLED AND AUDITED AT LEAST ONCE EVERY THREE YEARS
- ✓ OUR SERVICE STATIONS ARE REQUIRED TO STOCK A QUANTITY OF APPROVED SPARE PARTS
- ✓ ONLY APPROVED AND TRAINED SERVICE ENGINEERS ARE AUTHORISED TO CARRY OUT THE WORK REQUIRED ON YOUR RAFT
- ✓ SERVICE ENGINEERS MUST ATTEND LIFERAFT SERVICING REFRESHER COURSES ONCE EVERY THREE YEARS
- ✓ TRAINING, AUDIT AND CERTIFICATION RECORDS ARE TRACKED THROUGH A GLOBAL SERVICING DATABASE TO MAINTAIN CONSISTENTLY HIGH SERVICING STANDARDS



## WORLD FAMOUS SAFETY AND SURVIVAL BRANDS.

Survival. Technology. These two words do more than merge to form our name, they encapsulate everything Survitec is about. We are extremely proud to include many of the world leading liferaft brands within our portfolio.

### THESE INCLUDE:

- ✓ RFD
- ✓ DSB
- ✓ SURVITECZODIAC
- ✓ EUROVINIL (EV)
- ✓ ELLIOT
- ✓ RFD TOYO
- ✓ CREWSAVER



## GET IN TOUCH

### **SURVITEC**

1-5 Beaufort Road, Birkenhead, CH41 1HQ, United Kingdom

**Email:** [info@survitecgroup.com](mailto:info@survitecgroup.com)

**www.survitecgroup.com**

### **Copyright Notice**

The copyright, trademarks, domain names and other intellectual property rights in all material and information in this presentation belongs to Survitec Group Limited. All rights are reserved.

### **Disclaimer**

This document provides general information about Survitec and its companies, its products and services, and summarises general capabilities and offerings which we deem to be of relevance to our customers. Whilst Survitec has taken appropriate steps to ensure the accuracy of the information contained in this document, Survitec gives no warranty regarding the accuracy or completeness of such information.

This presentation was prepared to provide information and does not constitute a contract. Survitec reserves the right, without prior notice, to change, delete, supplement, or otherwise amend at any time the information, images, and offerings contained in this presentation, or other documents. Survitec shall not be liable for any loss or damage of whatever nature (whether direct, indirect, consequential or other) that may arise as a result of any third party relying on the information contained in this document (but nothing in this disclaimer excludes liability for death or personal injury arising from negligence or any fraudulent misrepresentation).

For further detailed information, prices, terms and conditions, customers should contact Survitec at [info@survitecgroup.com](mailto:info@survitecgroup.com)

